

技术参数:

- 材料: 压铸铝
- 盖子材料: PC
- 表面处理: 粉末喷涂
- 颜色: RAL 7037 (灰色)
- 温度范围: $-40^{\circ}\text{C} - +125^{\circ}\text{C}$
- 防护等级: IP65 (联锁状态, IEC 60529)
- 出线方向: 侧出线
- 出线孔数: 1
- 螺纹规格: M40
- 联锁元件:
 - 锁扣方式: 金属单扣
 - 材料: 不锈钢
- 密封元件: NBR

Technical specification:

- Material: aluminium die-cast
- Material, cover: PC
- Surface: powder-coated
- Colour: RAL 7037(grey)
- Temperature range: $-40^{\circ}\text{C} - +125^{\circ}\text{C}$
- Degree of protection: IP65 (acc.to IEC 60529 for coupled connector)
- Cable entry: side entry
- No. of cable entries: 1
- Thread size: M40
- Locking element:
 - Locking type: single locking latch
 - material: stainless steel
- Hoods/Housings sealing: NBR

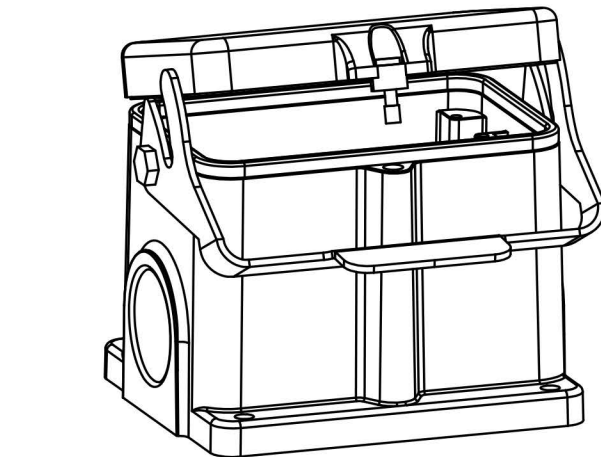

				表面处理 Finish				-				图号 Drawing No.		-	
				材料 Material				-				产品代号 Part Code		H48B-SDR-LB-M40	
标记 Mark	处数 Number	变更描述/Description		签名 Signature	日期 Date					产品料号 Part No.		1620480140			
		姓名/Name	日期/Date		姓名/Name	日期/Date	比例 Scale	版本 REV.	重量 Weight	数量 Qty.	产品名称 Part Name		-		
绘图 Drawn			18.10.2010	标准化 Stand.	-	-	2:5	V1.0	1386g	-					
审核 Checked			18.10.2010												
工艺 Process		-	-	批准 Approved		18.10.2010			All Dimensions in mm Original Size DIN A 4				浙江西霸士电气有限公司		